

MEANDER Solo (Obdélníková 1800 x 900) akrylátová

Není součástí dodávky:

Sada noh není standardní součástí dodávky.

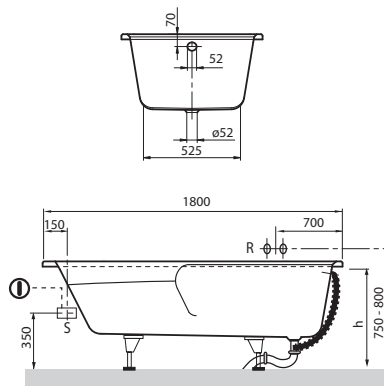

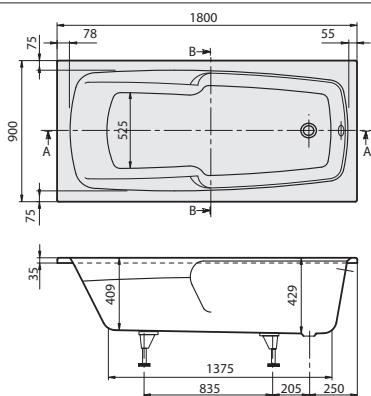

























R = Příklad pro nástěnnou baterii S = Příklad pro přívod proudu

Objednací číslo	Název a provedení	Rozměry d x š	Rozměry dna d x š	Hloubka	Obsah (l) vč. 1 osoby	Váha kg	Vestavná výška (h)	Cena
BA 180 MEA 2V-XX	Meander	1800 x 900	1380 x 590	429	197	27	540	1.502,-
BA 180 MEA 2HGV-XX	Meander, vč. úchyťů pro madla							

Příslušenství k vanám:

Objednací číslo	Popis	Cena
900PS189PRO2BFN	Pro box, pro montáž do niky (jen čelní krycí panel a rám), 1800 x 900 x 625 mm	420,-
900PS189PRO2BCN	Pro box, pro montáž do rohu (čelní krycí panel, koncový krycí panel a rám), 1800 x 900 x 625 mm	546,-
900Y1	TouchLight, 1 bodové LED světlo s bílým světlem, předmontované	551,-
900Y3	TouchLight, 1 bodové LED světlo s barevným světlem (6 barev a střídavý režim), předmontované	595,-
400000266	Nohy pro vany, plastové, pro vany s plochým dnem, nastavitelné od 145 do 180 mm	74,-
88820000	2 kovové nohy a nástěnná konzole, nastavitelné od 130 – 200 mm	100,-
90950461	Vhodná odpadová a přepadová armatura, NOVÝ, chromováno	154,-
90600361	Multiplex Trio, NOVÝ, chromováno	384,-
90600461	Multiplex Trio, vč. přerušení potrubí, NOVÝ, chromováno	625,-
91360061	Madla, 1 pár = 2 madla, chromováno	267,-
9009060000	Opěrka hlavy, světle modrá	138,-
99480000	Otvory, pro armatury ve vanách/dřevěné konzole	24,-

Vhodné pro následující masážní systémy (cena bez vany):

Kód masážního systému	WAE	WWE	WCE	FAE	FWE	FCE
Montážní výška (až k okraji)	575 / 615	575 / 615	575 / 615	575 / 615	575 / 615	575 / 615
Výška multiboxu	625	625	625	625	625	625
Počet trysek	8	8	16	12	16	28
Cena	2.596,-	2.596,-	4.820,-	2.921,-	3.815,-	6.371,-
Příslušenství k masážnímu systému podle modelu	   	    	    	   	   	   

Vysvětlivky k masážním systémům a příslušenství Whisper & Ultimate Fitness viz levá výklopná strana.

Whisper & Ultimate Fitness
Umístění technických částí 1

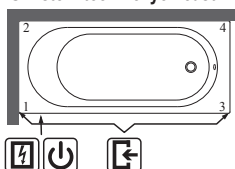

Whisper & Ultimate Fitness
Umístění technických částí 2

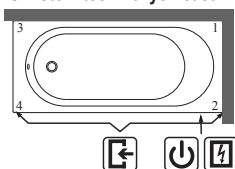

Přístup přes



Spínací skříňka



Ovládání na okraji vany